

HÖRMANN SCHÖRGHUBER

# PORTAL 38

**CONSUMPTION**

INFORMATION FOR ARCHITECTS FROM HÖRMANN AND SCHÖRGHUBER

ANDREA ROOST ARCHITEKTEN, ECE PROJECT MANAGEMENT, KADAWITTFELDARCHITEKTUR, ZAHA HADID ARCHITECTS





Sahara natural matt

Caramel natural matt

Ivory natural matt

Smoked Oak natural matt

Pebble natural matt

Chocolate natural matt

Pebble silk matt

Bog Oak, natural matt

Lava natural matt

Bog Oak, silk matt

Terra natural matt

Smoke Grey, natural matt

Natural brushed natural matt



Design by Schörghuber

# Wood & Veneer

Natural look and feel with the new surface finish collection "Stained Oak".

- » Stained in ten colours and one brushed natural finish
- » Noble natural timber finish ranging from matt to silk-gloss
- » Horizontally and vertically veneered versions

Contact us – we would be glad to advise you!





### Dear Readers,

Zalando, Amazon & co. are changing our consumer behaviour – and our cities. Once the venerable gentleman's outfitter and the local bookstore give up, retail spaces will probably remain vacant for a long time. Shopping streets become problem areas – and suddenly the online challenge faced by retailers also becomes an architectural task. After all, the urban atmosphere of inner cities thrives on the hubs of diverse retail outlets. Once these go out of business, the new derelict areas cannot be revived by any number of public measures. Urbanity is not created by office buildings but by people who meet in attractive locations, in shops, in front of window displays and in street cafes. Luckily, there still remain some successful examples of stationary

retail, which we would like to highlight in this issue. In Mönchengladbach, kadawittfeldarchitektur relied on the effects of a powerful facade. In Beijing, one of Zaha Hadid's last projects was a spectacularly large building. In Bern, Andrea Roost proved that the more subtle means of architecture are also still very effective. Finally, our author Peter Thode competently describes how successful shopping centres are created – he has already designed a few and we will present you with one of the most recent ones. We hope you enjoy this issue.

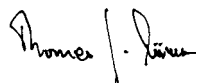
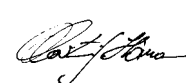
    
Christoph Hörmann      Thomas J. Hörmann      Martin J. Hörmann

Personally liable general partners

**ABOUT THE TOPIC: SHOPPING CENTRES AS A CHALLENGE AND OPPORTUNITY FOR GERMAN ARCHITECTS**



**INITIAL SPARK  
AQUIS PLAZA IN AACHEN, DE**



**CITY ORGANISER  
POSTPARC IN BERN, CH**



**POWERHOUSE:  
MINTO IN MÖNCHENGLADBACH, DE**



**EYE-CATCHER  
GALAXY SOHO IN BEIJING, CN**



**CORPORATE NEWS  
HÖRMANN AND SCHÖRGHUBER**



**TECHNOLOGY**  
**HÖRMANN AND SCHÖRGHUBER**

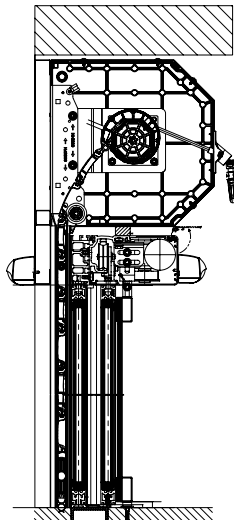

**ARCHITECTURE AND ART**  
**LEIF TRENKLER**



**RECENTLY IN ... BAD MÜNSTEREIFEL**  
**HEINO**



# CONTENTS

**04 CONTENTS/IMPRINT**

**06 ABOUT THE TOPIC**

High potential: Shopping centres as a challenge and opportunity for German architects

**12 POWERHOUSE: MINTO IN MÖNCHENGLADBACH, DE**

kadawittfeldarchitektur, Aachen, DE

**22 INITIAL SPARK: AQUIS PLAZA IN AACHEN, DE**

ECE Projektmanagement, Hamburg, DE

**28 EYE-CATCHER: GALAXY SOHO IN BEIJING, CN**

Zaha Hadid Architects, London, GB

**34 CITY ORGANISER: POSTPARC IN BERN, CH**

Andrea Roost Architekten, Bern, CH

**42 CORPORATE NEWS**

**46 TECHNOLOGY**

**48 ARCHITECTURE AND ART**

Leif Trenkler

**50 RECENTLY IN ... BAD MÜNSTEREIFEL**

Heino

**51 PREVIEW**

Munich

## IMPRINT

**EDITOR**

Hörmann KG Verkaufsgesellschaft  
P.O. Box 1261  
DE-33792 Steinhagen  
Upheider Weg 94-98  
DE-33803 Steinhagen, Germany  
Telephone: +49 5204 915-167  
Fax: +49 5204 915-341  
E-mail: pr@hoermann.com  
Internet: www.hoermann.com

Schörghuber Spezialtüren KG  
P.O. Box 1323  
DE-84536 Ampfing  
Neuhaus 3  
DE-84539 Ampfing  
Telephone: +49 8636 503-0  
Fax: +49 8636 503-811  
E-mail: pr@schoerghuber.de  
Internet: www.schoerghuber.de

**EDITORS**

Lisa Modest, Verena Lambers (Hörmann KG)

Architect's Mind GmbH  
Stuttgart, Deutschland  
www.architectsmind.de  
Dr. Dietmar Danner  
Daniel Najock  
Christina Dragoi

**PRINTING**

Hans Gieselmann Druck und  
Medienhaus GmbH & Co. KG  
Ackerstraße 54  
DE-33649 Bielefeld

This journal and all the articles and illustrations contained therein are protected by copyright. The publishing house and editors do not assume any responsibility for unsolicited photographs and manuscripts. Address data processing is handled by Heinze GmbH for Hörmann KG. Printed in Germany — Imprimé en Allemagne

Title photo: Iwan Baan, Amsterdam, NL



Galleria Vittorio Emanuele 2 by Giuseppe Mengoni in Milano.

**ABOUT THE TOPIC: CONSUMPTION**

# **HIGH POTENTIAL**

## **SHOPPING CENTRES AS A CHALLENGE AND OPPORTUNITY FOR GERMAN ARCHITECTS**

By Peter Thode

**Is consumption architecture a task for architects? Yes, very much so – says Peter Thode, Head of Creative Design Department Architecture at ECE, the European market leader for inner-city shopping centres. Unfortunately, however, not in Germany. The large projects around the world are predominately designed by other companies. Peter Thode deplors this and explains the urban planning responsibility of architects.**

ECE currently operates 196 shopping centres in Germany and Europe – and a large number of these were planned and constructed by us. For more than 50 years we have known what architecture and interior design should look like to be actually accepted by the customers and appreciated by the retailers. Yet I am very sorry to say that in Germany architects who design shopping centres are not exactly considered to be among the architecture Avant-garde. But at least the public image of this architectural task is increasingly improving. After all, planning a publicly accessible building with various uses such as retail, gastronomy, entertainment, and an all-round comfortable atmosphere is very demanding. And yet, nowadays shopping is one of the factors by which German inner cities are primarily defined. During the 1960s at the latest, this architecture of consumption became a key urban planning factor. It may be subject to criticism and considered a deterioration of urbanity – yet retail areas and restaurant concepts are responsible for the life of inner cities even after hours when offices have long since shut and the streets are empty in front of public buildings. Meeting people, spending time with them and shopping together have become the major drivers of urban development, constituting tasks that should be adopted and handled responsibly by architects. This is because the changes in consumer behaviour due to online trade not only threaten just a few traditional shop

owners. They threaten German inner cities as a whole, which makes them an architectural and urban planning task. At any rate, this challenge can no longer be denied. Anyone who persists in doing so is acting irresponsibly. Incidentally: the design of retail spaces offers very large work potential for German architects, which, with a few exceptions, up to now unfortunately was left to major international architectural firms. I wonder why this is the case? After all, when it comes to anything from stadiums to healthcare architecture, German architects are among the global elite. Only when it comes to consumption architecture there seems to be a blind spot in the line of vision of our self-employed colleagues. What they lack, with a few famous exceptions, is interest in these architectural tasks and thus the specialised knowledge of the firm rules of functionality and the development of stationary trade in the era of Amazon and Zalando.

### **Emotions and stories**

ECE operates a large architectural firm with around 300 architects and engineers. In addition, the tasks corresponding to performance phase 1 of the "Honorarordnung für Architekten und Ingenieure" (HOAI – fee regulations for architects and engineers), the so-called creative phase, are handled by our specialised department with a total of 30 staff members. Given this background, we are very well aware of why some shopping centres are successful and others are not. And one thing has become very clear to us – the most important aspect of a project is always the clever combination of function and emotion. The proper functional planning, fuelled by an emotional component based on the location, the history and the future target customers, determines the success or failure of a shopping centre. This is the "bread and butter" at the beginning of each planning process. How are the customers guided through the shopping centres? How can we reduce the "annoyance factors" that may cause the visitors of the centre to turn to a different location next time? In architecture firms who lack the expert knowledge this creative approach is undermined by the experience gained from other projects.

### **The visitors' intuition**

This is because the position of escalators and lifts is not an obvious choice that can be derived from office and public buildings or simply looked up in a textbook. It is not about complying with the spontaneous wishes of the clients and their intuitive routes. The intuition of visitors must be awakened first. They want and need to be guided. If this is not the case, they are instead overwhelmed by the wealth of what is on offer and in the worst case feel disoriented and uncomfortable. In contrast, with good functional planning they are guided from one anchor store to the next without feeling compelled to do so. (In the jargon of retail planners, anchor stores are the central shopping brands that are most likely to attract visitor traffic). This way, highly dangerous dead areas can be avoided in a shopping centre. While strolling, visitors always feel entertained – and all shop owners benefit from a steady stream of passers-by. This is also why the required parking areas are not placed underground whenever possible, but instead on parking levels above the shopping zones. This saves money, ventilation is less costly – and visitors trickle slowly from the car park downwards through all retail floors. Even if it sounds almost commonplace – the lavatories are also part of well thought-out functional planning. They must be easy to find, generously proportioned, clinically clean, nicely scented and, most importantly, far from any hint of the sleazy image from which they often suffered in the past. In this area in particular there remains much to be done. I have seen lavatories in international shopping centres that can compete with those of the lobbies of 5-star luxury hotels. Customers often decide between the urinal and vanity mirror whether they feel comfortable about their visit to the shopping centre and would like to come back or not. This also has to do with the architecturally expressed appreciation of the customers, including both shop tenants as well as retail customers. Most importantly, however, the shopping centre must tell a coherent story throughout all public areas. A story that makes the visit an event and that is ideally closely associated to the urban setting.

### **Seeing and being seen**

Such a “story” can even revive totally neglected shopping arcades of the 1970s, which otherwise turned into “no-go” areas in the inner cities. A telling example of this is the “Marstall” in Ludwigsburg. Situated in the immediate vicinity of the city's castle grounds, a mere two of 70 stores were let. ECE revived the historic Marstall premises and used their former role as the theme for the renovation. The horse stables of the Duke of Württemberg used to be the dominant urban structure of this site next to the Baroque castle. We have brought this historical detail, which is important for Ludwigsburg, back to life. With oversized stable doors, bronze horses and numerous little historical relics. The project is meaningful, urban and perfectly suited to the local context. Above all, the huge success of the project among the citizens of Ludwigsburg proved us right. The formerly criticised area became a showcase for the city. In addition, in co-operation with the city of Ludwigsburg, wide outside staircases were erected that extend from the shopping centre to the public domain. These allow visitors to see the life on the city streets (or be seen themselves). After all: people are mainly interested in people – and architecture should provide the proper framework for that. Even at the high cost of the wide staircase destroying potential retail spaces in the “Marstall” that could otherwise have been let expensively. Yet such human presentation areas are also at the core of successful functional architecture.

### **Increased importance of restaurants**

For this reason, restaurant areas are also becoming increasingly important. Many years ago these used to constitute a mere three per cent of the total area of shopping centres. Today we know that at least ten per cent are required. After all, the “post-shopping cappuccino” has become important for visitors. This is where they discuss their purchases with their friends. This is also where they meet acquaintances to whom they can show their finds. This trend is greatly increasing. In our projects in eastern Europe



we already need 12 to 15 per cent for dining areas, as there are no shop opening laws like in Germany. In China, 30 to 50 per cent of dining spaces are required. Anyone designing shopping centres should take this into account and design the dining areas in such a way that they meet the needs of the centre itself as well as of the surrounding urban setting.

### Stuttgart's "axle"

In and around Stuttgart, a number of large new shopping centres have been and are currently under construction. We are involved in a few of them. "Our" Milaneo together with the "Gerber" constitute the terminal points of Stuttgart's "inner axle", which was thus considerably extended at both ends of the Königstraße. Another developer added the above-mentioned "Gerber" at the upper end of the very neglected Gerber district. At the other end, we constructed the Milaneo, featuring large dining areas and additional residential floors in a new city district on the premises of the former goods station, between new office buildings and the newly constructed city library. And it is exceptionally successful. All that, as we believe, without diminishing the buying power in the established shopping streets. Quite to the contrary: the Milaneo upgrades the city further. One of our anchor tenants, the Irish Primark chain, is currently opening another large shop in the Königstraße. To us it was always understood that the "Milaneo" would have high-scale architecture and interior design. Nowadays shopping centres must definitely be more "edgy" in terms of design. The expectations of consumers regarding the quality of interior design are constantly increasing. We must not lag behind this trend. We must set the standards ourselves. In Stuttgart we practically managed this on our own. In other projects we often like to co-operate with well-known German architecture firms to whom we commission the design of the facade. On the interior we often work with interior designers. As a general rule, the design of shopping centres should appeal to the majority of shoppers. As opposed to the past, however, shopping centres must at the same time be at the top of the Avant-garde. Drawing an analogy to the automotive

Photo: ECE



Shopping centre Marstall in Ludwigsburg.

Photo: ECE



Shopping centre Milaneo in Stuttgart.



Photo: tupungato / iStock

Seeing and being seen is a basic instinct – as seen here on the Spanish Steps in Rome. This architecture element is also used in malls.

**Author: Peter Thode**

has been working for ECE since 1991, including stations in Poland and Russia. Since 2009 he has been employed at the headquarters in Hamburg, since 2012 as Head of Department Creative Design. He already implemented around one hundred projects. One of the most recent ones is the Aquis Plaza in Aachen that we are presenting on page 22 of PORTAL. [www.ece.com](http://www.ece.com)

industry, the models of Volkswagen did not stop at the latently conservative “Jetta”. Today, the same car symbolizes contemporary design and its driver is no longer seen with a nodding dog on the rear window shelf.

**Mixed businesses and marketing**

In addition, as always we were careful in the above mentioned Stuttgart example to comply with all the functional planning factors that I have listed previously. This is precisely where I see the key difference to other, perhaps not as successful, centre concepts in the region. The second key difference is certainly the professional centre management. The fact that architecture and interior design must be appropriate is a basic prerequisite. Added to this, however, are soft factors such as the diversity of businesses and the general marketing. It is crucial to offer the suitable brands to all potential visitors of a centre. Especially since former large tenants such as Saturn or Media Markt are adopting new concepts and are rather reducing their areas and concentrating their offers.

**Discovering new grounds**

This creates room for “more” brand diversity – and not just “more” of the same. In a centre there should always be room for different and primarily new “discoveries”. Boredom must not be allowed. This is why fitness and beauty service providers are increasingly moving in along with other sectors that were unthinkable in a mall a few years ago. The car park will also soon be much more than a place to deposit one’s car. There is a growing trend of service offers to wash the vehicle by hand and clean its interior. When the family returns from its shopping tour, the car is shiny and clean. Since all is in vain if the “story” of a shopping centre cannot be “read” by its visitors, we also offer solutions in this regard. While our department at ECE consists of architects and interior designers in the classic sense, we actually consider ourselves to rather be brand architects whose input is very welcome even when choosing a name and developing a logo.



Photo: ECE, Hamburg, DE

As opposed to standard agencies, however, our work extends far beyond the shops of the individual retailers and in the best of cases deep into the urban space. In Stuttgart, a space located among office buildings that are only active during the day was turned into a new urban centre. With the Aquis Plaza in Aachen we managed to upgrade a part of the inner city that had become problematic and to create an initiative for other investors and architectural interventions. This is the often-criticised consumption architecture at its best.



VAPIANO PASTA | PIZZA | BAR

VAPIANO PASTA | PIZZA | BAR

# POWERHOUSE

CONSUMPTION IN MÖNCHENGLADBACH:  
MINTO BY KADAWITTFELDARCHITEKTUR





Generously two-storey high – the central hall.

**A confident large architectural body for a shopping centre is the answer of kadawittfeldarchitektur to the missing genius loci in the main shopping street of Mönchengladbach. The new Minto interacts with its heterogeneous surroundings, revives the customer's purchasing power and creates an urban flair.**

Ranked 113 on the Internet list of Germany's largest shopping malls? Not bad – for Mönchengladbach at least. Regardless of who actually has the largest temple of consumerism, the Minto is obviously rather large and the citizens of Mönchengladbach are at any rate extremely proud of it. This is because even though the city's consumer highway Hindenburgstraße is as wide as the A2 highway, it offers just as much (or as little) architectural diversity. The Aachen architects kadawittfeldarchitektur have now considerably changed this with the facade of the Minto.

**Genius loci**

Unoccupied spaces in the previous mall of the 1980s diminished the purchasing power and attractiveness of the city near the lower Rhine. In addition, the city that was severely damaged in the war is not exactly blessed with an urban flair that would by itself attract streams of visitors as potential consumers. This is why kadawittfeldarchitektur must have found it difficult to find something of a "genius loci" to which their design could have referred. It was therefore only logical that they would choose a mostly unrelated large shape that offered many other advantages instead. The positioning of staggered facade strips reacts to their respective locations. The strips protrude and retreat, render the street space narrower or wider, create terrace areas or guide visitors directly to the "abyss" of the shopping centre. Instead of trying to focus on the city's non-existing central themes, they worked with volumes and spatial edges.

As is often the case with fractured inner city locations with many plots and owners, the shopping centre does not have a clearly-defined exterior boundary. While it extends along the edge of the block in many areas, in other areas it drops behind an existing building, only to appear a few metres further down at the edge of the pavement. All this is no problem to the facade strips. Even though its neighbouring buildings are heterogeneous – the Minto has a uniform look that is pleasantly dominating and formative.

**New urban centre**

The vertically positioned ceramics sections all feature the terracotta colour range in eleven hues ranging from red to ochre. This effect was achieved without colour glazing simply by mixing different clays. The guiding themes were the kiln clinkers typical of the lower Rhine region. The outcome is not only compelling in terms of design and cost effective, it is also – relatively – vandal-proof. As there are no even surfaces, sprayers cannot really become active. If it does happen, then the affected section can be precisely and simply replaced. On the inside, the Minto benefits from the local topography. Thanks to its position on a slope, three of its four floors can be accessed at ground level – offering little discouragement to visiting Mönchengladbach citizens. The shopping centre is not perceived as a huge foreign body, but as a continuation of the city. The required 600 parking spaces are situated on two floors above the shopping areas, which is the established current standard for inner-city shopping centres. With the Minto, kadawittfeldarchitektur and the client "mfi – Management für Immobilien AG" were able to accomplish the predefined goal. Mönchengladbach has received a new urban centre – and not a mere temple of consumption. The local press is euphoric – and the local residents sit on the terraces and stairs and contently enjoy the sunshine. This is what architectural success looks like.



The large food court of the Minto.



Restaurant areas are becoming increasingly important in shopping centres.



Various viewing angles facilitate orientation.



The powerful facade creates a new centre for Mönchengladbach. The advertising spaces are integrated and not only placed on top.





# Hörmann expertise: Fire-rated and smoke-tight doors as well as fire sliding doors

Hörmann is represented at the Minto shopping centre in Mönchengladbach with around 450 steel fire-rated and smoke-tight doors. In many cases they are equipped with hinged gate operators to guarantee comfortable and barrier-free access. The wishes of the concerned tenants were taken into account. In addition, 19 fire protection exterior doors with approval for each individual case were fitted. The four fire sliding doors located near the lifts to the two parking decks are perfectly incorporated into the modern architecture. They are fully fitted into the wall and close automatically in

case of fire. In normal operation, the visitor does not see the doors. Only the 18 centimetre wide steel recess flaps their function. When closed, wicket doors allow the passage in case of emergency. It is also possible to fit the fire sliding doors without a guiding profile on the opposite wall. With this option, spring-loaded stainless steel guiding bolts are inserted into small guide areas to secure the door flush with the wall.



In case of fire, the fire sliding door seals the room in front of the elevators. It moves out of the wall when required.



The fire sliding door is hidden behind a recess flap.



External doors are located in the partially roofed inner courtyard of the delivery area.

**Location:** Am Minto 3, 41061 Mönchengladbach, DE  
**Client:** mfi Shopping Center Management GmbH/Unibail-Rodamco Germany, Düsseldorf, DE  
**Design architecture:** Heine Architekten, Hamburg, DE  
**Facade architecture:** kadawittfeldarchitektur, Aachen, DE  
**Implementation architecture:** Planungsgruppe Schmitz + Partner, Wuppertal, DE  
**Construction engineer:** Kempen Krause Hartmann, Düsseldorf, DE  
**Construction manager + project supervision:** Borgmann Architekten und Ingenieure, Aachen, DE  
**Net floor area:** 75,555 m<sup>2</sup>

**Gross floor area:** 81,265 m<sup>2</sup>  
**Gross volume:** 374,731 m<sup>3</sup>  
**Facade area:** approx. 8000 m<sup>2</sup>  
**Retail space:** 41,846 m<sup>2</sup>  
**Completion:** 2015  
**Photos:** Stephan Falk, Berlin, DE  
**Hörmann contact person:** Frank Hott, Cologne, DE  
**Hörmann products:** 450 sheet steel doors: H3 single and double-leaf, RS-55 single and double-leaf, D45 + D55 single-leaf, H16, 4 T30/T90 fire sliding doors



Floor plan of the ground floor

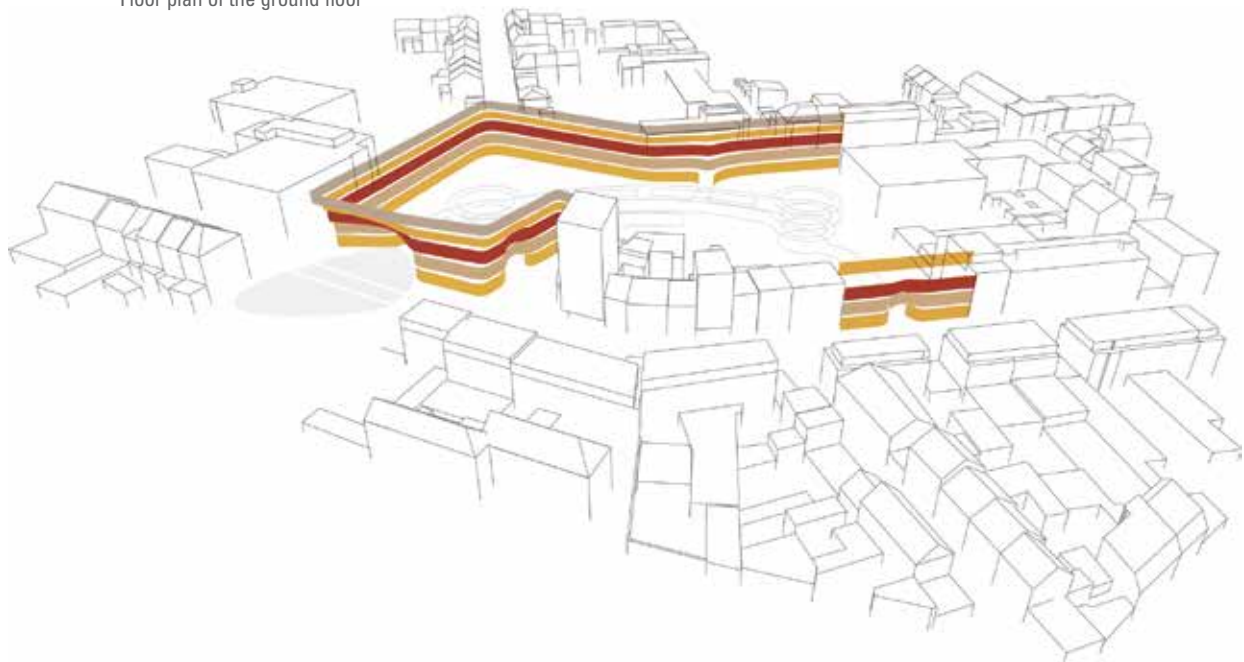

Facade concept

## Architect Thorsten Schäfer about the successful collaboration with Hörmann



**Expert consulting is one of the keys for the success of projects in terms of architecture, structural engineering and budget planning. We talked to engineer Thorsten Schäfer of the planning agency Schmitz + Partner, who was in charge of planning the Minto shopping centre, and the responsible Hörmann architecture consultant and engineer Jan Lücke, about their experiences.**

### **What matters to you most when collaborating with companies?**

We require knowledgeable consultants, quick response times – and absolutely reliable information. If, as was the case with the Minto project, we only have very limited time for implementation planning, we need to receive the required information on which we can rely within four weeks. It is pointless to promise us the moon. We don't want to have any unpleasant surprises when it comes to the specifications.

### **And Hörmann fulfils all these requirements?**

Yes – or else we would not collaborate with them as regularly as we do. In the Mönchengladbach project also, a large number of Hörmann products were used. Communication with their architecture consultants is always problem-free and without much ado. We feel that they understand our architectural and planning requests. Usually a few telephone calls and the exchange of details and blueprints by e-mail are enough. Personal meetings are actually only required from time to time simply to keep up the personal contact and to exchange information about recent developments.

### **Is it important to you as architects that the consultant be also an architect?**

It certainly facilitates communication. One can communicate at eye level and be sure that both sides are clear on the issues discussed. Mr Lücke can not only read details, but also blueprints from which he can deduce the architectural connections. This makes things considerably more efficient. Of course, we take it for granted that Hörmann is an expert on

doors and fire safety measures, and we're never disappointed in this regard.

### **Was the Minto a special project for your agency?**

Not really. We have already planned the implementation of many very large shopping centres. The only difference for the Minto was the very generous, two-storey hall and the very tight schedule. In this case we only became involved at a very late stage and therefore had to plan even faster than usual. However, with the help of the equally flexible architecture consultants, for example Hörmann, everything went very well.



Double-leaf fire-rated and smoke-tight door in the Minto.

## Jan Lücke, architecture consultant at Hörmann, about his everyday challenges



Hörmann architecture consultation – on site ...



... and also online with the Hörmann Architects' Program.

**Engineer Jan Lücke is an architecture consultant at Hörmann and supported implementation planning of the planning agency Schmitz + Partner. Holding a degree in architecture and having worked for several years as an architect he knows the questions and problems faced by planners and how Hörmann can provide answers and solutions to them.**

“We architecture consultants at Hörmann are no more than interpreters. That means we facilitate communication between architects and manufacturers. Both have their own 'language', their own way of communication and their own understanding of architecture. This may sound as if there are frequent misunderstandings in the communication, but that would be an exaggeration. Nevertheless, with our help, subject-specific and design requirements and challenges regarding the planning of doors can be quickly and easily mastered. When talking to the architects we must be insistent without seeming intrusive. We should also not take our business too seriously – after all, architects do not only plan doors. It is also important to empathise with the other side and adjust to their style. We not only understand the technical details of our products but also the plans and expectations of the architects. At the same time, we do not hold back with our opinion and directly tell the architect if some ideas cannot be implemented. Yet general statements such as “this won't work” are not productive. This is why we always aim to present solutions. At the end of the day, the sooner we are consulted during the planning the greater the planning reliability for the architect. Wrong plans can be detected early and resulting costs avoided. In addition, by dealing this honestly and directly with each other, we often receive the unfiltered opinion of our products. This helps us understand requirements and potentially adjust our products accordingly.”



WIR ZIEHEN  
DIE ZEIGENALLE  
DIE GANZE WELT

hays

# INITIAL SPARK

CONSUMPTION IN AACHEN

AQUIS PLAZA BY ECE PROJEKTMANAGEMENT





The project includes residences designed by blauraum.

**From a dubious area of Aachen to a booming quarter – the new Aquis Plaza by ECE and blauraum Architekten became the initial spark for the upgrade of an entire urban district. Professionally designed consumption became the driver of an urban process.**

Every city has its dubious area. It is a specific mix of derelict Wilhelminian-era buildings, permanently provisionally filled lots of buildings destroyed in the war and sex shops with uncertain futures. Under ideal circumstances, this low-price neighbourhood is discovered by a local creative subculture. Following a brief phase in which studios, workshops and ateliers dominate, it then becomes the next “in” quarter with that highly coveted mix of residences for well-off academics and an authentic multicultural mix of trades and shops, which is highly appreciated as a picturesque backdrop by realtors. In contrast, if things don't go well then the inner city area continues to deteriorate. It is then as poor as Berlin but refuses to become as sexy, as described by its former mayor Wowereit.

**Initial spark**

In such cases, the city administrators sigh an audible sigh of relief when they find a solvent investor who first resolves the often convoluted owner structures and then does what had often been neglected for decades. In Aachen, this task was taken on by ECE of Hamburg in co-operation with the project developer Strabag Real Estate who stepped in and invested € 290 million to construct almost 30,000 square meters of retail space, plus 33 apartments and 600 parking lots. This created 700 new jobs – and most importantly an initial spark that seems to pull along the immediate environment of the new shopping centre. Visitors of the Aquis Plaza arriving by car first descend deeply underground between the thousand-year-old St. Adalbert church and the entrance gate of the centre, drive through

the technical innards and are then guided along a never-ending spiral to the roof floors. This layout is deliberate. When customers enter the centre from the top, then they inevitably and slowly trickle as customers through all floors – just like coffee in a percolator.

**Entertainment and special experience**

This is good for the shop owners on the top floors – and good for strolling visitors. Because a mall does not serve the immediate fulfilment of basic needs. Visitors to a shopping centre expect entertainment and a special experience. This is exactly what the Aquis Plaza was designed to offer, as it consists primarily of a central axis with many visual angles. There is much to see – and at any point there is always a view to the outside as well. St. Adalbert in particular once again becomes a visible constant element. A residential block (required by the city) located inside the refurbished quarter was designed by blauraum Architekten of Hamburg, and the Aquis Plaza designed by ECE architects themselves is complemented by another commercial building on the side of the spherical fountain.

**City-friendly dimensions**

This division offered city-friendly dimensions and a luxurious link between two key public squares of Aachen. This puts it in stark contrast to the dark and low washed-out concrete shopping streets of the 1970s. High-quality materials and a design that at the same time appeals to the majority of visitors and conveys to average consumers an impression of Avant-garde ensure that the plaza is not solely seen as a short-lived temple of consumption, but as an initial spark with a sustainable effect for an entire quarter.





The customers are distributed across the plaza from the parking deck.

## Hörmann expertise: Fire rated doors and smoke-tight doors and fire sliding doors

Fire protection plays an important role in all places where humans gather. For example at the Aquis Plaza shopping centre in Aachen. Hörmann provided the project with approximately 500 single-leaf and double-leaf T30 and T90 steel fire-rated and smoke-tight doors in different versions. They are fitted on the inside in many shops, the hallways and passages to various storage and secondary rooms, as well as on the outside. In passage areas like those leading to the parking decks, the sheet steel doors were coloured Anthracite grey matching the overall design to harmoniously integrate them. At the Aquis

Plaza, large building segments are separated from each other in case of fire by Hörmann fire sliding doors. When open, the fire sliding doors are located invisibly inside the wall and close automatically in case of fire. To allow the passage of pedestrians when the door is closed, wicket doors without thresholds were additionally integrated into the doors.



In case of fire, fire sliding doors extend from the wall to separate the individual fire protection zones from each other.



External door with ventilation slats. Double-leaf fire-rated and smoke-tight doors protect the escape routes to the outside.

**Location:** Adalbertstraße 100, 52062 Aachen, DE

**Owner:** ECE Projektmanagement GmbH & Co. KG, Hamburg, DE

**Shopping centre architecture:** ECE Projektmanagement GmbH & Co. KG, Hamburg, DE

**Residential construction architecture:** blauraum, Hamburg, DE

**Processor:** Ed. Züblin AG, Hamburg, DE

**Gross floor area:** 84,000 m<sup>2</sup>

**Retail space:** approx. 29,200 m<sup>2</sup>

**Construction costs:** approx. € 290 million

**Completion:** 2015

**Photos:** Stephan Falk, Berlin, DE

**Hörmann contact person:** Johannes Schmidt, Cologne, DE

**Hörmann products:** approx. 500 single and double-leaf fire-rated doors H3, H16, single and double-leaf T30, T90 sheet steel doors STS/STU, single and double-leaf smoke-tight doors RS55, 10 T30/T90 fire sliding doors

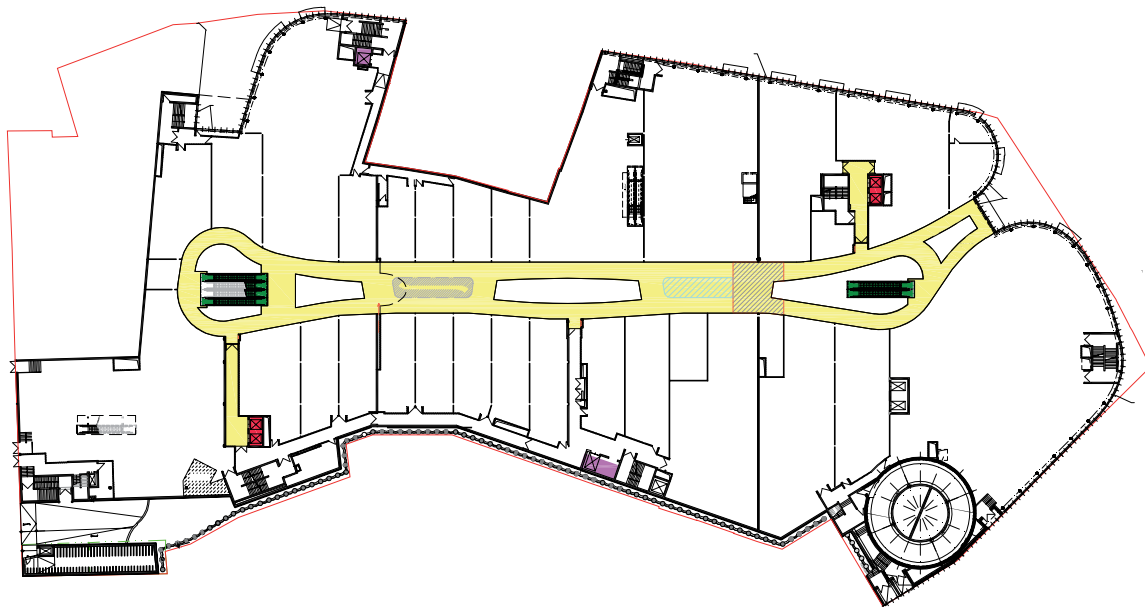

Floor plan for the first floor

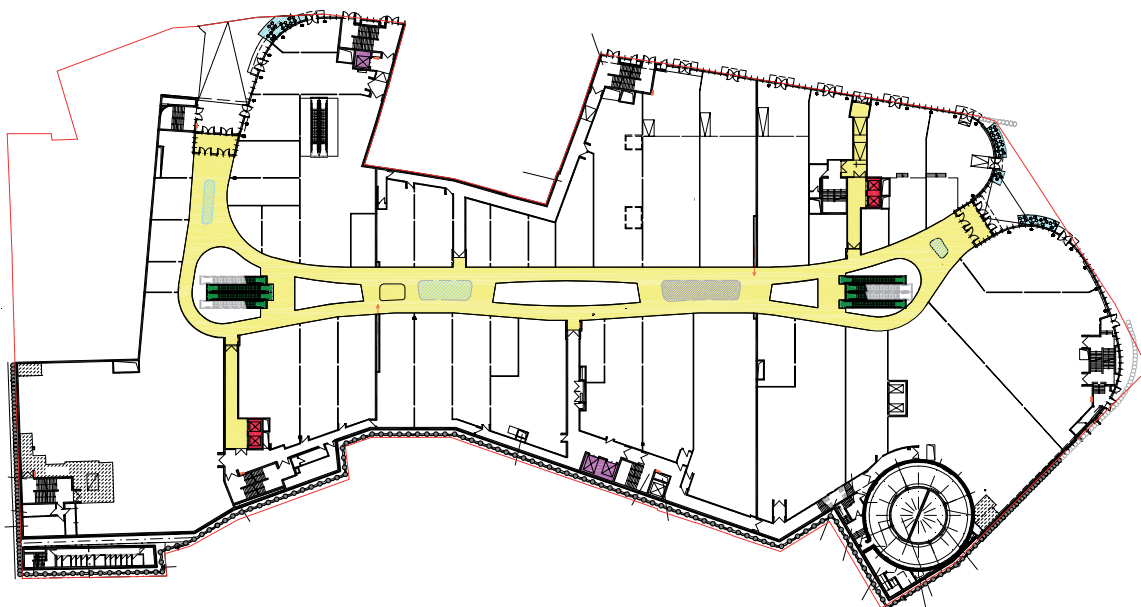

Floor plan of the ground floor

# EYE-CATCHER

CONSUMPTION IN BEIJING:  
GALAXY SOHO BY ZAHA HADID ARCHITECTS





北京广播电视台

品质

精采  
内容

爱国

创新

内容



The access area between the four towers called “canyon”.

**According to Zaha Hadid and Patrik Schumacher, parametricism is not only the legitimate successor of modernism – but can also be applied to every construction project. In Beijing, many large urban building complexes have such spectacular parametric shapes that ensure they receive the attention they deserve and give them a futuristic look.**

This Beijing complex was completed as one of late Zaha Hadid’s last projects, who died this year. With nearly 333,000 square meters of useful area, the Galaxy SOHO almost constitutes an independent city district. These huge dimensions and the building complex obviously justified the use of a parametric design method defined by Hadid’s partner Patrik Schumacher. This is because “parametricism” employs computer-based design methods to deliver the ideal building for the owner, the user and the urban development context, taking into account all associate functional and design parameters.

#### **Legitimate successor of modernism**

In almost every case, the information provided to the computer results in a highly spectacular shape that creates the intended sensation among the public and puts an unmistakable stamp on the location as well as on the structure. And it really doesn’t matter if you are dealing with a parametric design for women’s shoes, flower vases, seating furniture or large-scale public architecture projects like the Galaxy SOHO. Aside from offices and entertainment spaces, shopping areas were supposed to dominate the space. It was of course an advantage that parametricism can be used on almost any design task and especially in any location in the world – that is why Patrik Schumacher describes it as both the legitimate successor of modernism and a new international style.

#### **Traditional internal courtyards**

When Hadid received the commission in 2009 to conceive an ambitious project for the Chinese investor, her goal with the Galaxy SOHO was to also be affected by the traditional Chinese architecture with the typical internal courtyards. So an additional parameter was defined for the computers in London to manage. And in the end this evolved into four towers up to 15-stories high, separated by a trench, nicknamed the “Canyon”, and linked to each other with sky bridges. In combination with a basement floor, this results in a spatial volume that is used for entertainment services up to the 34th floor. All floors located above are used as office spaces.

#### **Pioneer work**

Since the parametric method of design generally produces soft and dynamically flowing shapes, it was particularly challenging finding a facade design that was not only appropriate but also economic. But above all, the aim was for the expressive shapes to still accommodate a reasonable amount of usable area. For this reason the curves often needed to be recalculated and readjusted in order to reduce the amount of multi-curved facade elements – but also without compromising the dynamic of the form. The complex shapes created numerous structural and production-related challenges – which in the end could only be tackled with the capabilities of building information modelling. The highly spectacular building brought about structural pioneering work and then eventually went to achieve its intended economic success.



According to Zaha Hadid, the covered internal courtyards of the Galaxy SOHO are supposed to integrate the motif of the internal courtyards found in historical Beijing homes.

## Hörmann expertise: Custom-made without door handles

Hörmann contributes 885 sheet steel doors to the project of Zaha Hadid. The doors provided are mainly used in areas leading to the office units and sanitary rooms. The ZKS-1 model was specially designed for the Galaxy SOHO: it features a specially shaped rebate and a corresponding counter piece, the custom-made 90 mm frame. Frames and doors are set flush in the wall. In order to not disturb the filigree style of the walls, the architects opted out from having a door handle on the exterior side of the doors. They can be easily pushed open without much effort.



The colour of the doors matches the colour of the ceilings. This was also specially designed for the Galaxy SOHO.



The doors open by pushing.



The doors are fitted flush with the slightly curved wall.



**Location:** No. 7A Xiao Pai Fang Hutong, Dongcheng District, Beijing, CN  
**Client:** SOHO China Ltd., Beijing, CN  
**Architect:** Zaha Hadid Architects, London, GB  
**Local architect:** BIAD Beijing Institute of Architecture & Design, Beijing, CN  
**Construction engineer:** Beijing Construction Design Institute, Beijing, CN  
**General contractor:** China Construction First Building (Group) Corporation Ltd, Beijing, CN  
**Gross floor area:** 328,204 m<sup>2</sup>  
**Office space:** 161,034 m<sup>2</sup>  
**Retail space:** 97,367 m<sup>2</sup>

**Building height:** 60 m  
**Completion:** 2013  
**Photos:** Chen Shu, Beijing, CN  
**Hörmann contact person:** Zhu Yuanbo, Beijing branch, CN  
**Hörmann products:** 885 internal doors ZKS-1 custom-made without door handles



Floor plan level 1

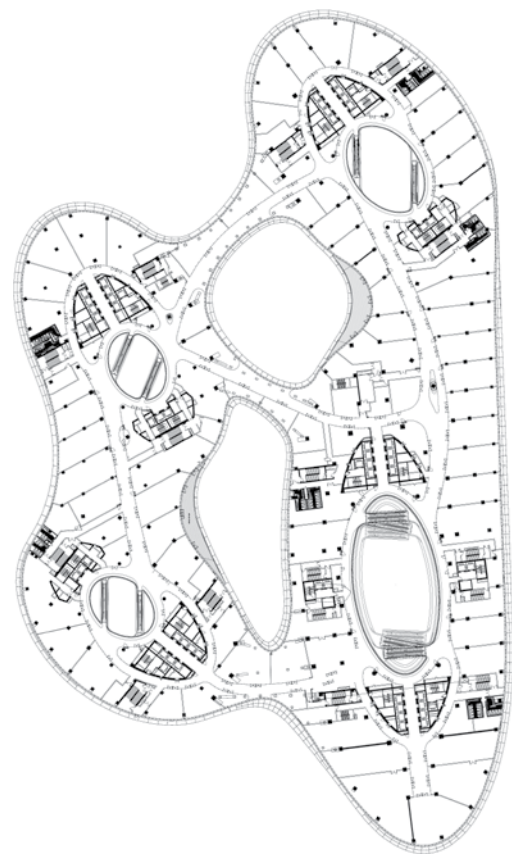

Floor plan level 3

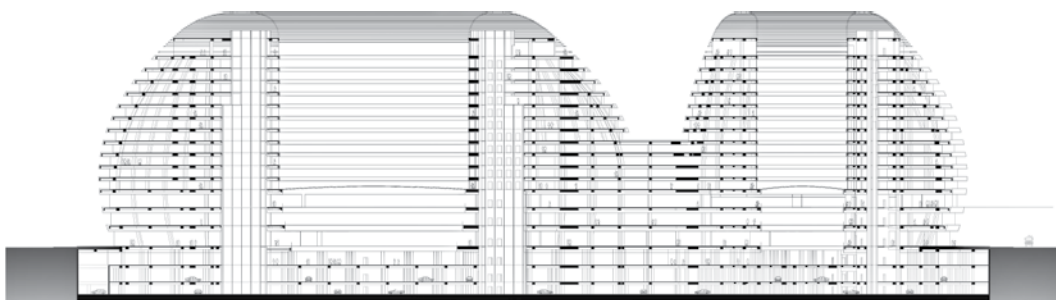

Section



# CITY ORGANISER

CONSUMPTION IN BERN:  
POSTPARC BY ANDREA ROOST ARCHITEKTEN





The sweeping roofs of the platforms are still under construction.

**Andrea Roost conducted a successful open-heart surgery on a city. For the PostParc in Bern, a genuine agglutination that had formed in the heart of the city above the central train station had to be carefully removed. Traffic areas, office spaces, restaurants and shopping zones were untangled, organised and then newly designed with a steady hand.**

The imposed show architecture and the enforced spectacular nature of some contemporary building seems diametrically opposed to the Swiss national character. Therefore in the Bern project any “means of cheerful facade shenanigans” as the architect himself put it, were deliberately avoided. Instead, Andrea Roost opted solely for “formal reduction” as design style. According to Roost, its “aesthetics is based on objectivity” and “within this context makes the inconspicuous conspicuous”.

#### **Heart of the capital**

The former Schanzenpost building is actually a core element of the Swiss capital that is accordingly crowded by railroad tracks, the central train station, various service functions and an office building. All of these elements are linked by various pedestrian connections and the long construction history additionally created a highly complicated building utilities system and difficult to assess statics. Instead of rendering this complex structure even more illegible by agitated shapes, Andrea Roost opted for the opposite strategy. He countered the unavoidable irregularity on the pedestrian level of the city floor by quiet large shapes and horizontal layers. The pedestrians were at the heart of the design. The connections within the premises are now more direct and the available spaces more generous. Two public city squares were added for which valuable rental space was sacrificed. A sacrifice that was worth it, because the new order is beneficial to the

location. It is not surprising that the project took a good ten years to complete. The existing building substance had to be preserved, constructively processed, utilities managed and, most importantly, functionally untangled. Quite along the way, the development potential of the railway located underneath should not be impaired. And most importantly – the heart of the capital never stopped beating throughout the process.

#### **Lively meeting point**

Just like any highly frequented traffic hub, a central station is always also a popular site for retail areas and restaurants, on the one hand to meet the immediate needs of travellers and on the other to turn the station into a meeting point. While the pure rental space on the ground floor was slightly reduced in favour of an enlarged public area and associated spatial qualities, the architects made sure during the planning of the retail areas to prevent a mono-structure, instead creating a highly diversified offer. The areas specified for dining establishments are intended to make the railway station a lively meeting point.

#### **Countering event architecture**

Overall, the design of the PostParc thus countered event architecture that employs large formal spectacles to cause a sensation and catch customer attention, while adding to the disorderliness of the cityscape. Often enough such buildings disregard the urban setting. The PostParc, however, proves that classical architectural tools can be employed at least equally successfully in complex spatial situations and sensitive locations. Andrea Roost rendered the cityscape of Bern clearer readable and this important hub remarkable.



Making the “inconspicuous conspicuous” was the aim of architect Andrea Roost.



A high percentage of existing areas that needed to be restructured at the heart of the city and above the railroad tracks had to be functionally readjusted.



The retail and dining areas in the PostParc were designed in such a way as to avoid mono-structures.

# Schörghuber expertise: Flush-fitting special doors made of timber

Schörghuber provided more than 750 special timber doors for the PostParc. The architects took care to apply a single colour scheme – the majority of doors is anthracite-coloured. Only the access doors to secondary rooms are white. On the office floors, the doors also feature flush-fitting glazed side elements. The use of glass elements improves the light incidence and results in a transparent design. Depending on their position in the PostParc, the Schörghuber doors had to fulfil different requirements. Fire-rated doors were mostly used and in part equipped

with additional functions such as smoke-tightness and acoustic insulation or burglar-proofing to meet the different functional requirements from the basement to the office spaces.



Fire, smoke and acoustic rated doors made of timber by Schörghuber were used throughout the entire building – including the basement and underground car park.



The panes are mounted flush-fitting with the frames.



Glass elements provide insights into the offices.



**Location:** Schanzenstraße 4/5, Bern, CH

**Client:** PostFinance AG, Bern, CH represented by Post Immobilien Management & Services AG

**Architect:** Andrea Roost Architekten, Bern, CH

**Construction engineer:** Henauer Gugler AG, Zurich, CH/Hartenbach + Wenger AG, Bern, CH

**General contractor:** Steiner AG, Bern, CH

**Gross floor area:** 53,000 m<sup>2</sup>

**Construction costs:** CHF 185 million

**Completion:** 2016

**Architecture photos:** Seraina Wirz, Zurich, CH/Stephan Falk, Berlin, DE

**Processor:** Strasser AG Thun, Thun, CH

**Schörghuber contact person:** Luca Cesari

**Schörghuber products:** T30 fire/smoke-tight doors single-leaf type 3, T30 fire-rated doors double-leaf type 4, T30 fire/acoustic-rated doors single leaf type 3, type 13, type 5 and double-leaf type 6, type 26, single-leaf type 16 and double-leaf type 4, double-leaf type 14, in part with climatic class III, T30 fire/acoustic-rated/burglar-proof doors double-leaf type 26, T30 fire-rated/burglar-proof door single-leaf type 3 in glazing 25 V, T30 fire/acoustic-rated/burglar-proof door double-leaf type 6, single-leaf type 16, single-leaf type 5, composite timber doors single-leaf type 3 and double-leaf type 4, acoustic-rated doors single-leaf type 5, frames: solid timber block frames, rebate frames, 4-sided all-round solid timber block frames

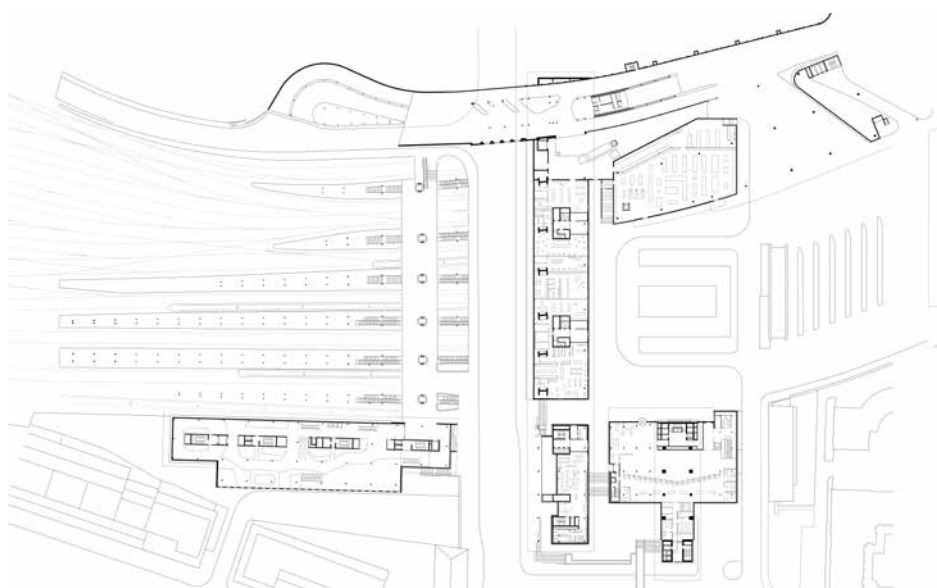

Top floor

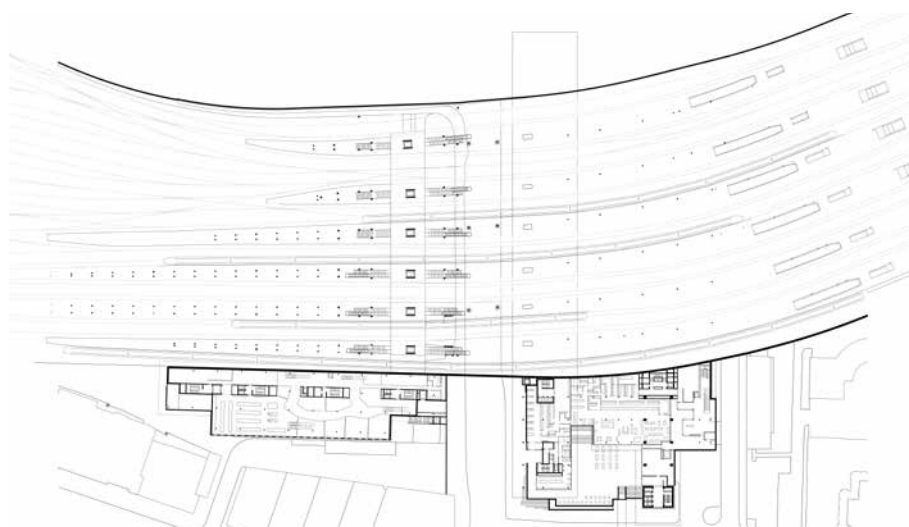

Ground floor

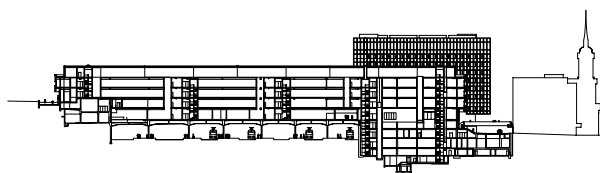

Section



Photo: Wege durch das Land (Paths through the country)

A great success: all seats were taken by the 550 visitors at the Hörmann factory in Amshausen.

## PIANO TUNES AND READING AT THE FACTORY

The location at which Hörmann usually produces, stores and loads garage doors on lorries looked quite different during an evening in early July 2016. Totally unrelated to its everyday operations, the Hörmann factory in Amshausen, located in the immediate vicinity of the Hörmann Group headquarters, hosted the literature and culture festival “Wege durch das Land” (paths through the country). This series of events has for 16 years taken its visitors to the most diverse

locations within the East-Westphalia-Lippe region – the multi-faceted literary-musical programme was already held at Renaissance castles, horse stables, aristocratic courts and on green meadows. Hörmann has supported and sponsored the literature and music festival for many years, and served this year for the first time as a host at one of its own factories. The steel high rise racks served as backgrounds for the reading by actress Leslie Malton and the concert of pianist Marc-André Hamelin. Every seat was taken by the 550 visitors. Leslie Malton read from her debut novel “Brief an meine Schwester”

(Letter to my sister). In her book, she writes about her sister, who is 11 months younger and suffers from the hereditary disease Rett syndrome. The reading was complemented by a photo exhibition of Malton and her sister. “Wege durch das Land” also brought Marc-André Hamelin, who is considered the best contemporary pianist, to the Hörmann factory. The Canadian musician and composer is usually found at the world's leading musical venues. He presented his piano interpretations of works by Franz Liszt and Samuel Feinberg, with his virtuosity resounding among the high rise racks and lorry loading bays.



Uwe Brandt, CFO of Hörmann (front right), received the award.

### HÖRMANN WINS CSR PEOPLE'S CHOICE AWARD OWL 2016

On 26 April 2016, the Initiative für Beschäftigung OWL and the Gilde GmbH Wirtschaftsförderung Detmold awarded the CSR award OWL 2016. Hörmann won the people's choice award in the category "Companies with more than 250 employees" in recognition of its sustainable commitment. Hörmann has been constantly expanding its commitment to employees, the environment and communities. For example, in 2016, the "Hörmann Academy" was founded offering partners and staff extensive continuing education programmes. The "MehrAusbildung" project supports high school students, trainees and university students with foreign exchange programmes, on-site

training or open days. Under the theme of "We think green", Hörmann combines several projects that improve the "ecological footprint" of the company. This includes the conversion to green electricity and the newly established solar power park for the power supply of the Hörmann factory in India. Refugee relief is another major area of concern. Hörmann offers free of charge accommodation and German language courses with the aim of "Regarding refugees as people". "Sustainability is becoming increasingly important nowadays. We want to set a positive example and hope to convince other companies of the benefits of sustainable actions," said Uwe Brandt, CFO at Hörmann, who accepted the award.

### BIELEFELD AWARD FOR "DIE WORTFINDER"

In early June, the registered association "Die Wortfinder" received the Bielefeld Award 2016. The association has been active for six years already promoting art and literature by special persons. The current publication of a four-volume encyclopaedia was sponsored by the family-owned company Hörmann of Steinhagen, Germany. "Die Wortfinder" was established in 2010 by psychologist Sabine Feldwieser and supports creative writing and related artistic activities by mentally challenged persons. The association's activities include the organisation of writing workshops and an annual literature contest.



Sabine Feldwieser (third from left) accepted the award.



Four books were published in early 2016.



Photo: Schörghuber

The derived timber frames with aluminium cover do not differ visually from aluminium frames.

## DERIVED TIMBER FRAMES WITH AN ALUMINIUM LOOK

Schörghuber developed a new manufacturing method for frames with which most of the derived timber frames of the manufacturer can be coated with 1.0 millimetre-thick aluminium sheet. The timber frames with an aluminium look are a less expensive alternative to aluminium frames, offering architects and planners more options in terms of thermal insulation, design and functions for equipping building projects. Due to their high-quality and modern look,

aluminium frames are often used in the interior design of building projects. However, planners and architects are often inhibited by the design and functional limits of the metal – due to their primarily firmly defined dimensions, the aluminium profiles only accommodate limited deviations and frame variations cannot be freely chosen. With timber frames, however, the dimensions and frame variations such as timber profile frames, rebate frames and timber block frames can be freely defined by planners and architects – depending on the application area and interior design,

and even special dimensions can be implemented precise to the millimetre. In addition, aluminium frames can only be combined in a limited way with specific functions, such as fire, smoke and acoustic insulation, in conjunction with additional features such as transom lights or side elements. On the other hand, the aluminium coating can be painted in any desired RAL or NCS colour. The combination of wood and aluminium results in a particularly sturdy frame design with excellent thermal insulation values. The timber frames with aluminium cover are available with concealed hinges, a door closer on the inside and various surface-mounted fittings.



Photo: Schörghuber

Timber rebate frame with an aluminium look.



Schörghuber presented two of its special doors at the architect@work trade fair.

## ARCHITECT@WORK 2016

Schörghuber presents visitors to the trade fair architect@work, which is held several times per year in various cities, a number of product innovations made of wood. The special feature of this fair: only manufacturers whose products were chosen as unique product innovations by an independent committee may participate. Schörghuber has already appeared four times at the architects' trade fair and was pleased with the outcome of this year's opening event in Luxembourg: "We are very satisfied with our launch at the fair and were able to welcome and consult many interested visitors. As in previous events, architects and trade visitors were greatly interested in our exhibits

and product range," said Alexander Reinstädler, field staff member at Schörghuber. After the successful launch at this year's architect@work in Luxembourg, Schörghuber will participate in three other cities this year. Architects and planners have the opportunity of seeing the special doors made of wood and receiving expert advice on location on the following dates: Schörghuber will be present from 12 to 13 October in Vienna, 9 to 10 November in Berlin and 7 to 8 December in Stuttgart with its own fair booth at the architect@work fair.

## SCHÖRGHUBER EXPANDS HPL SURFACE FINISH RANGE BY AN ADDITIONAL DESIGN

Schörghuber expanded its HPL surface finish offer by an additional design for door leaves and timber frames – the new surface coating "Schörghuber Diamond white" is a solid coloured and especially smooth HPL laminated material. Consisting of multiple decor papers impregnated with melamine resin, the laminated material fully conceals dark base material, providing doors with a uniform white look. The "Diamond white" design for door leaves and timber frames resembles premium coating in RAL 9016 for which it is a less expensive alternative. In addition, the 0.8 mm thick surface coating has the properties of HPL (High Pressure Laminates), making it much more robust than painted surface finishes. The new design version "Diamond white" is available for all door leaves and timber frames from Schörghuber and can be combined with all functions such as fire and smoke protection, acoustic insulation and radiation protection as well as burglar-proofing, bullet-proofing and wet room suitability. For even more robustness, we recommend combining it with the new ABS (acrylonitrile butadiene styrene) edge from Schörghuber.



In combination with the smooth door leaf edge, the door leaf appears uniform.

# TECHNOLOGY: HÖRMANN AUTOMATIC SLIDING DOOR IN COMBINATION WITH ROLLING GRILLE

**Application areas:** To secure shops with spatial constraints, as is frequently the case for petrol stations, pharmacies, jewellers and shopping centres, this inexpensive combination of automatic sliding door AD 100-X and rolling grille HG 75 TD offers a barrier-free and break-in-resistant solution. During daytime operation, the rolling grille is open and the automatic sliding door with sensors allows the secure passage of persons. During nighttime operation, the automatic sliding door is firmly shut and the rolling grille offers break-in-resistance according to RC 2. The combination is certified as an escape route door and can be integrated into the overall design of the building thanks to RAL to choose.

**Model:** Automatic sliding door AD 100-X in combination with rolling grille HG 75 TD **Version:** single and double-leaf **Main functions:** recommended for barrier-free construction, personal security, break-in-resistance, certified as an escape route door; profile system automatic sliding door AD 100-X: aluminium extrusion profile, fine frame **Profile system rolling grille HG 75 TD:** aluminium extrusion profile **Curtain type rolling grille HG 75 TD:** perforated (rectangle 100 × 40 mm) **Perforation:** offset or straight arrangement **Fitting dimensions:** RAMW = 2160 mm, RAMH = 2830 mm **Max. size:** RAMW = 6000 mm, RAMH = 3335 mm **Fitting depth:** 335 mm **Fitting in:** brickwork **Fitting:** 1) Fitting in the opening, behind the lintel 2) Fitting in the opening with additional fascia panel 3) Fitting from the inside behind the opening **Design:** RAL to choose **Operator control:** automatic sliding door AD 100-X with programming switch, rolling grille HG 75 TD with press-and-hold control via key switch **Opening speed (adjustable):** 55 – 75 cm/s **Closing speed (adjustable):** 10 – 50 cm/s **Hold-open phase (adjustable):** 0 – 180 s **Equipment:** Insulated glazing 22 mm with safety glass, combination detector inside/outside, protection leaf **Optional extras:** Rolling grille HG 75 TD with crank handle

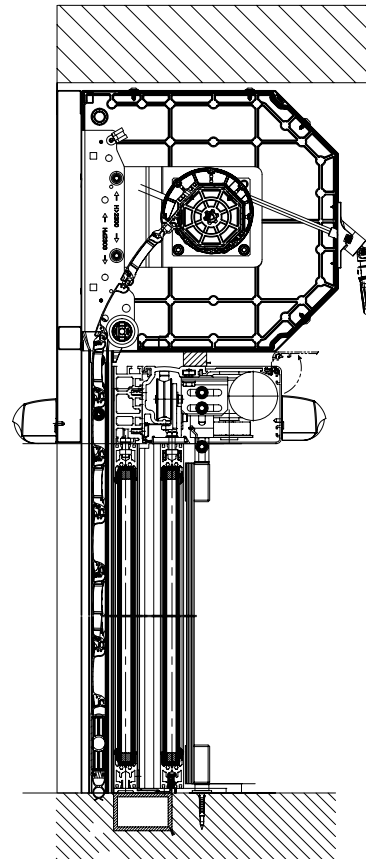

Detail of the rolling grille box



Shops are securely closed by the combination of automatic sliding door and rolling grille.



Break-in-resistant rolling grille of class RC 2.

Photos: Hörmann

# TECHNOLOGY: SCHÖRGHUBER DOUBLE-LEAF HALLWAY AND PASSAGE DOOR

**Application areas:** In public buildings, it is legally required to create fire zones and provide escape routes. In case of hazard, doors must secure the escape routes for people present in the building and close in case of fire to prevent its spread. As hallways and stairways are frequently used as escape routes, fire-rated and smoke-tight doors must secure these areas from spreading fire while serving as passages at the same time. To fulfil these requirements, the double-leaf hallway and passage door from Schörghuber is available as a fire-retarding T30 version or fire-proof T90 version and can additionally be equipped with compensator door closers, closers with hold-open devices and panic locks. To ensure accessibility, the door solutions can be combined with automatic hinged door operators and electric openers.

**Product:** Double-leaf hallway and passage door **Version:** T30 type 4, 14 (50 mm door thickness), T30 type 6, 26 (70 mm door thickness), T90 type 24 (70 mm door thickness) **Frames:** timber frames, steel frames, aluminium frames **Fitting in:** brickwork with grouting lug, light blockwork, parallel to wall construction with anchor bracket **Functions:** fire protection T30, T90, smoke protection RS, acoustic insulation  $R_{w,P} = 32, 37, 42, 45$  dB, break-in resistance RC 2, RC 3, suitable for wet rooms, suitable for humid rooms, composite timber **Nominal sizes (width×height):** double-leaf 1375 – 3500 mm × 625 – 3500 mm (4000 mm with top section) **Optional equipment:** compensator door closer, closer with hold-open device, automatic hinged door operators, electric opener, magnetic and latch contact, alarm contact element, panic locks, motor locks, access controls, combination with glazing type 25 V

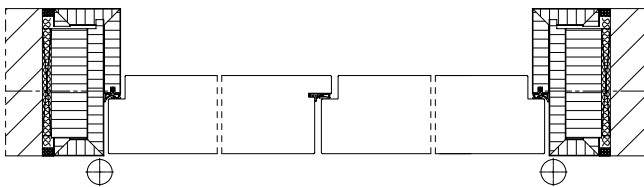

Horizontal view

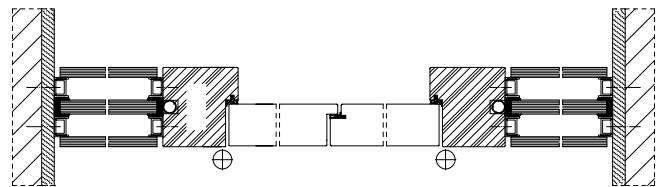

Horizontal view



Fire and acoustic-rated door with timber lining frame without decorative rebate.



Fire/smoke-tight door with flush-fitting glazing.

Pictures: Schörghuber

# ARCHITECTURE AND ART

## LEIF TRENKLER



Etwas Unwirkliches (Something unreal) (2015),  
50 × 40 cm  
Photo: Simon Vogel



2030 (2016), 90 × 70 cm  
Photo: Uwe Walter



Das Telefonat (The telephone call) (2016),  
130 × 98 cm  
Photo: Simon Vogel

### **In his paintings, Leif Trenkler presents trivial everyday scenes. The public realm plays a major role.**

Leif Trenkler's paintings are striking. The relentless oversaturation of colours catches the attention. Even though the viewer, based on the unspectacular everyday subjects, may initially almost feel part of this world, the surroundings seem unreal. What is behind this? Leif Trenkler is one of the influential representatives of the New Figuration, a wave of contemporary art focusing on critical realism. His work is therefore based on snapshots capturing moments of reality he encounters during travels or banal everyday life. At his studio, he dissects these shots, reduces them to their essence and adds other elements. In many of his most recent works the public realm occupies a large area of the

picture. Persons are not striving into the foreground and are sometimes only seen from behind. This creates a suction effect that virtually draws the viewer into the picture. His earlier works were quite different: back then, Leif Trenkler used to place people at the centre. Often he would even only present excerpts of his models. They practically closed in on the viewer, creating an almost intimate atmosphere. There is one characteristic that is shared by his older and younger works – while the scenery is rather unspectacular, the strong contrasts of light and shadow and the irritating effect of the unnatural colours create intense sensations – turning inconspicuous events into magical moments.



**Artist: Leif Trenkler**

born 1960 in Wiesbaden, DE  
studied at the Städelschule in Frankfurt/Main from 1984 to 1986. After a one-year stay at the Kunstakademie Düsseldorf he returned to Frankfurt where he studied under Thomas Bayle and Christa Näher until 1990. This was followed by a one-year foreign exchange scholarship by the "Studienstiftung des deutschen Volkes" in Italy. Since the early 1990s, the work of Leif Trenkler has been presented in many group and individual exhibitions. He is considered to be a renowned and influential representative of New Figuration.  
Galerie Jochen Hempel, Spinnereistraße 7, 04179 Leipzig, DE  
[www.jochenhempel.com](http://www.jochenhempel.com)



Photo: Yvonne Cornelius



Am Atlantik (At the Atlantic) (2015), 98 x 130 cm  
Photo: Simon Vogel

## RECENTLY IN ... BAD MÜNSTEREIFEL



Photo: Starwatch / Michael Petersohn

**The picturesque Bad Münstereifel is a novelty in Germany. It was the site of the first outlet centre in a historic city district. Many residents were critical of the project. One of them is the singer Heino. What does he have to say about his city?**

### **What brought a native of Dusseldorf to Bad Münstereifel?**

I wanted a bit more peace and quiet and initially moved to Ülpnich. However, my wife Hannelore missed the mountains that she loved so much in her native Upper Austria. While the Eifel cannot be compared to the Alps, I wanted to alleviate her longing at least a little bit. We then looked at Bad Münstereifel and she liked it so much that we ended up moving to it.

### **You ran the Café Heino for many years there – until there was a change in operator. How are you still connected to the Café?**

I ran the café for around 17 years and really enjoyed it. When Bad Münstereifel became an outlet town I had the opportunity to buy the building, but refused. Today the cafe is located

slightly above the historic district in the former wellness and therapy centre in which we also live. While I don't operate it myself anymore, I still like to visit it.

### **Can you recommend something from the menu?**

I usually order a piece of Frankfurter Kranz – a cake filled with buttercream that consists of several layers of sand cake, sponge cake or biscuit cake. Excellent! My wife, however, prefers the apple pie.

### **What are the cultural highlights of Bad Münstereifel?**

For me personally it is the annual Christmas carol event that I organise in December for three or four days at the wellness and therapy centre.

### **Does Bad Münstereifel inspire your work?**

I travel a lot due to my music and find inspiration everywhere, including journeys. Bad Münstereifel, on the other hand, offers me primarily one thing – my home. This is where I feel good. It is where I can relax.



Photo: eurotravel / iStock

Bad Münstereifel has a picturesque historic city centre.



Photo: Joerg H. Wagner

Heino resides in the old wellness and therapy centre above the historic district.

### Artist: Heino

born 1938 in Dusseldorf, DE

Heino originally completed professional training as a pastry chef, but quickly turned to music. His first hit single was released in 1966. Heino has sold more than 50 million music media since then. He is also involved in TV shows, most recently as a jury member of the casting show "Deutschland sucht den Superstar". Despite all his previous success, "Mit Freundlichen Grüßen" released in 2013 was his first number one album on the German charts. Most recently, Heino released on the occasion of the European Soccer Championship the album "Songs rund um das Leder" in which he interprets popular football songs.

[www.heino.de](http://www.heino.de)

### How did the City Outlet change the city?

Initially I had to come to terms with the solution of the city outlet for reviving the city. Like many other residents I was very sceptical at first, but have stood corrected. The concept is actually very beneficial to the city. Its effects are being felt and nowadays the centre is revived.

### What should one visit in Bad Münstereifel if one has not only come for shopping?

The biggest highlight is definitely the historic district itself – the many half-timbered houses, the old city walls, the gates, the spa gardens – the whole composition is small, beautiful and homey.

### What is your personal relationship to architecture?

The biggest part of my life is occupied by music. There is little room left for the other arts. Nevertheless: When I walk through Bad Münstereifel, I enjoy the old half-timbered houses. In my opinion, in earlier times construction was more beautiful, more friendly and more congenial than today.



Photo: Joerg H. Wagner

The former wellness and therapy centre also houses the Café Heino – with his trophies.

## Topic of the next issue of PORTAL: Munich

Every two years, new standards are set in Munich. This is when the construction industry meets at the BAU trade fair to present its best innovations and greatest achievements. In 2015, around 250,000 visitors were sure not to miss the world's leading fair for architecture, materials and systems. But it is not only the fair itself that attracts architects to the Bavarian capital. The accompanying programme is also very attractive. There are many lectures by famous architects and experts and important awards are distributed. The long night of architecture is equally interesting for many visitors. Around 50 buildings open their doors, offering around 30,000 visitors insights that they would not get otherwise. In the past two years, Hörmann was also involved in a large number of projects in and around Munich. We will present a selection of these in the next issue of PORTAL.



16.–21. Januar · München



Photo: Oliver Weber / iStock

At the time of the BAU, it is still rather cold in the outdoor beer gardens.

EDELSTAHL®  
**Rost  
frei**



## Shiny stainless steel solutions for highest hygiene standards

- Flush-fitting fire-rated and smoke-tight doors combine fire safety and hygiene requirements in modern architectural concepts
- Visibility windows and frames fulfil special requirements of hospitals or restaurants
- Fire and smoke protection sliding doors subdivide fire zones in production halls of the food industry
- High-speed doors expedite work processes and lower energy costs in food production

**HÖRMANN**  
Doors for Home and Industry